



BID NUMBER

DOT-CHR-24/25-0031

DESCRIPTION:

SUPPLY AND DELIVERY OF PARK HOMES AT WHITTLESEA CAMP IN ENOCH MGIJIMA LOCAL MUNICIPAL AREA FOR THE CHRIS HANI DISTRICT AT THE DEPARTMENT OF TRANSPORT.

Issued by:

Supply Chain Management Unit

Department of Transport

Private Bag X7185

KOMANI

5320

NAME OF BIDDER: _____

CSD NUMBER : _____

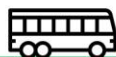

INVITATION TO BID

BID NUMBER: DOT-CHR-24/25-0031

DESCRIPTION: SUPPLY AND DELIVERY OF PARK HOMES AT WHITTLESEA CAMP IN ENOCH MGIJIMA LOCAL MUNICIPAL AREA FOR THE CHRIS HANI DISTRICT AT THE DEPARTMENT OF TRANSPORT

CLOSING DATE: 06 SEPTEMBER 2024 | Time: 11H00

COMPULSORY BRIEFING: There will be compulsory briefing on: MONDAY 02 SEPTEMBER 2024 - 14:00 AT DEPARTMENT OF ROADS AND PUBLIC WORKS DEPO OPPOSITE HEWU HOSPITAL WHITTLESEA

The completed RFQ (Request for Quotation) must be placed in a sealed envelope, clearly marked with the Bid number and the Nature of the Service, and be deposited in the Bid Box situated at 1st Floor No. 92 Cathcart Road ,Sanlam Building Komani , not later than **11H00 on 06 SEPTEMBER 2024**

Bidders must take particular note of the following:

- Service providers are kindly requested to submit price quotations on the attached pricing schedule for the specified items / service.
- By submitting the price quotation, it is accepted that you fully understand the requirements of this invitation and have familiarized yourself with the General Conditions of Contract (GCC) available on National Treasury website.
- The tender will be evaluated according to the preferential procurement model in the preferential Procurement Policy Framework Act (PPPFA 5 of 2000): Preferential Procurement Regulations, 2022 as well as the SCM Policy of the Department of Transport.
- In the case of a JV tender, each party must supply a valid tax certificate and a letter of good standing.
- The tenderers must ensure that they complete and sign the ECBD 1, ECBD 4, ECBD 6.1
- The amount reflected on the Form of Offer and Acceptance takes precedence over any other total amount indicated elsewhere in the Bidders tender submission. If the Form of Offer and Acceptance has no value or figure, the bidder will be regarded as having made no offer and therefore non-responsive.
- Bidders must have provided supporting documentation as per the bid specification schedule requirement;
- Bidders who are not registered for VAT are not eligible to claim VAT in their pricing;

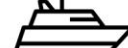
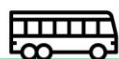

DESCRIPTION: SUPPLY AND DELIVERY OF PARK HOMES AT WHITTLESEA CAMP IN ENOCH MGIJIMA LOCAL MUNICIPAL ARE FOR THE CHRIS HAN DISTRICT AT THE DEPARTMENT OF TRANSPORT

- Bidders should take note that price is not a determining factor to award the bid.

Furthermore, quotation offers will only be accepted if:

- Bidders are registered with Central Supplier Database (CSD) with Treasury prior to submitting this RFQ (see <https://secure.csd.gov.za/>).
- The tenderer is in good standing with SARS as verified on the Central Supplier Database.
- The tenderer or any its directors or shareholders is not listed on the register of tender defaulters in terms of the prevention and compacting of corrupt activities Act of 2004 as a person prohibited from doing business within the public sector.
- The tenderer has not abused the employers Supply Chain Management System or failed to perform on any previous contract and has been given written notice to this effect.
- All quotations shall be held valid for 60 days after the closing date. The Department reserves the right not to accept the lowest or any tender.

Enquiries should be directed to:

SCM

Ms. N SKWEYIYA
Tel No: 066 116 5148
Noluvuyo.skweyiya@ectransport.gov.za

TECHNICAL

Mr. Solomzi Lunika
| Cell: 071 490 8558
solomzi.lunika@ectransport.gov.za

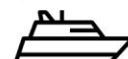
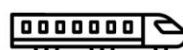
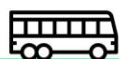

SPECIFICATION

ITEM	Description	Size	Quantity
1	Kitchen sink, cup boards, mixer include delivery to (Whittlesea)	4.2m x 2.4m	1
2	Ablution and change room 2 toilets 2 basins and 2 showers include delivery to (Whittlesea)	4.2m x 2.4m	2
3	Insulated Park home (Rooms) 4 room,4 exit, door light and window, double plug include delivery to (Whittlesea)	12m x 3m	2

Please refer to the next page for the layout plan



DOT-CHR-24/25-0031

DESCRIPTION: SUPPLY AND DELIVERY OF PARK HOMES AT WHITTLESEA CAMP IN ENOCH MGIJIMA LOCAL MUNICIPAL ARE FOR THE CHRIS HAN DISTRICT AT THE DEPARTMENT OF TRANSPORT

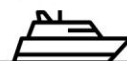
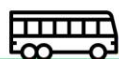
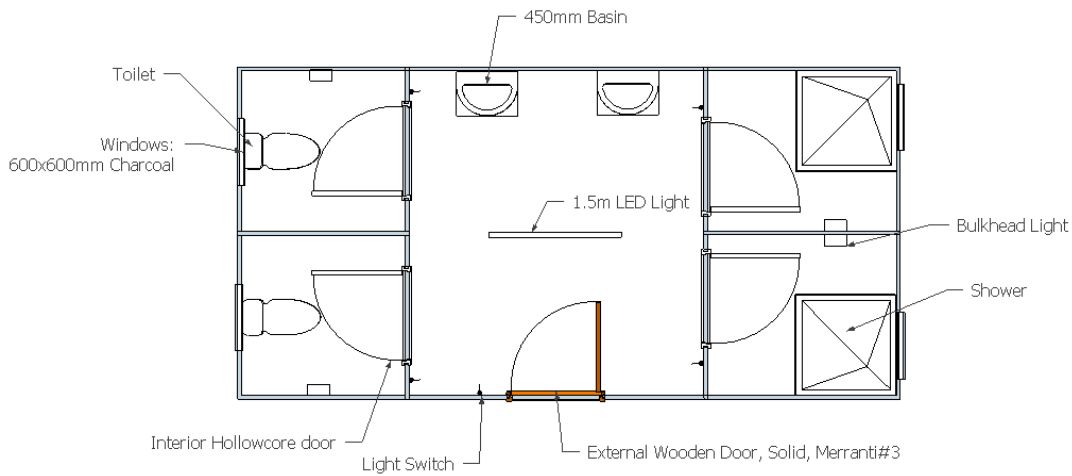
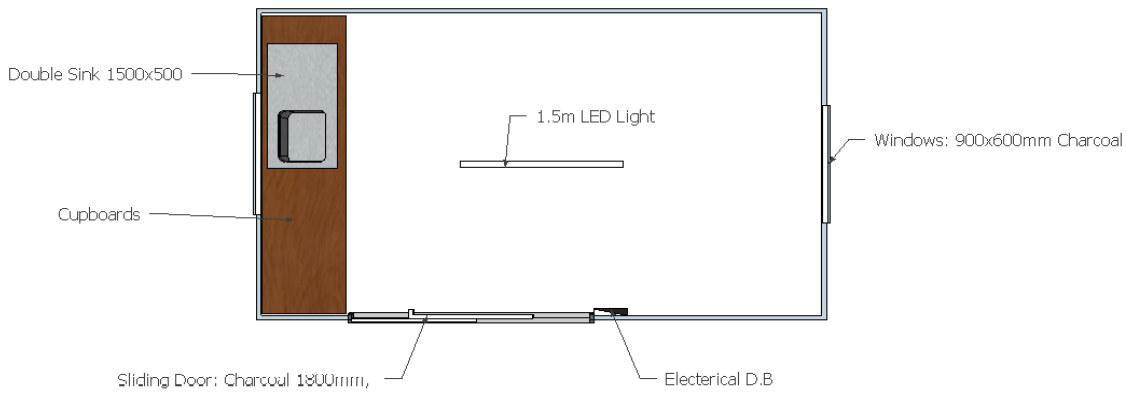
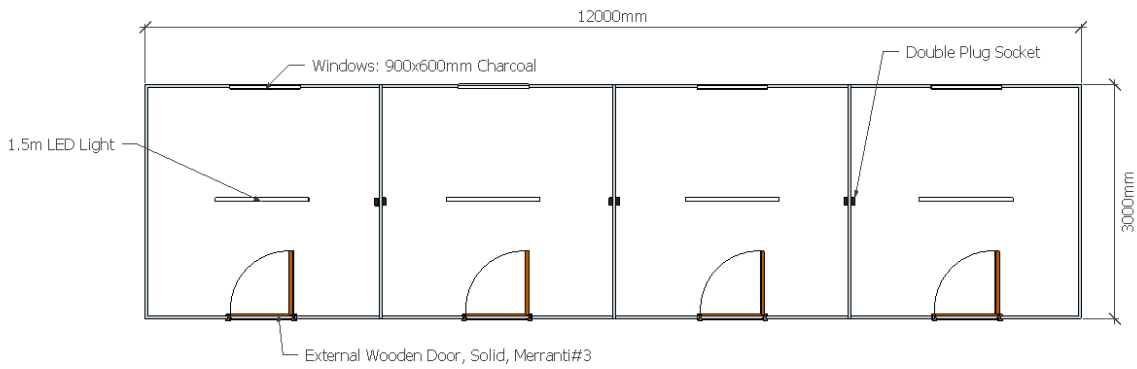

An efficient, safe, sustainable, affordable and accessible transport system

QUOTATION EVALUATION CRITERIA

1. EVALUATION CRITERIA:

The following criteria shall apply:-

- The tender will be evaluated according to the preferential procurement model in the preferential Procurement Policy Framework Act (PPPFA 5 of 2000): Preferential Procurement Regulations, 2022 as well as the SCM Policy of the Department of Transport.

1.1. Price:

- 80 points will be awarded to the bidder submitting the lowest price (all other bidders will receive points proportionately thereto):

1.2. Calculation of points for specific goals

- The tenderer will be allocated points based on the goals stated in table 1 below as may be supported by proof/ documentation stated in the conditions of this tender

PREFERENTIAL SPECIFIC GOALS POINTS TABLE		
The specific goals allocated points in terms of this tender	Number of points allocated (80/20 system) (To be completed by the organ of state)	Number of points claimed (80/20 system) (To be completed by the tenderer)
Historically Disadvantaged Individuals Ownership		
Black ownership	4	% ownership
black women ownership	4	% ownership
black youth ownership	4	% ownership
disabled people ownership	4	
Locality:-		
(a) Chris Hani District Municipality	4	
(b) Outside – Chris Hani District Municipality	2	

1.3. Bidders are required to submit, together with their bids, the following: -

1.3.1. Service providers must submit proof of its Specific Goals points claimed / status of contributor.

1.3.2. The Specific Goals supporting documents required to verify claimed points may inline with the specified requirements include:

- Disability Ownership: valid medical documentary proof.
- Military Veterans Ownership: valid proof of veteran status.

* The Central Supplier Database will be used to verify the specific goals other than the specific goals stated under paragraph 1.3

1.3.3. A bid will not be disqualified from the bidding process if the bidder does not submit a certificate substantiating the SPECIFIC GOALS. Such bidders will score 0 out of maximum of 20 points for SPECIFIC GOALS

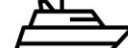

DOT-CHR-24/25-0031

DESCRIPTION: SUPPLY AND DELIVERY OF PARK HOMES AT WHITTLESEA CAMP IN ENOCH MGIJIMA LOCAL MUNICIPAL ARE FOR THE CHRIS HAN DISTRICT AT THE DEPARTMENT OF TRANSPORT

ECBD1

PART A
INVITATION TO BID

YOU ARE HEREBY INVITED TO BID FOR REQUIREMENTS OF THE (DEPARTMENT OF TRANSPORT)					
BID NUMBER:	DOT-CHR-24/25-0031	CLOSING DATE:	06-09-2024	CLOSING TIME:	11H00
DESCRIPTION	SUPPLY AND DELIVERY OF PARK HOMES AT WHITTLESEA CAMP IN THE ENOCH MGIJIMA LOCAL MUNICIPALITY				
THE SUCCESSFUL BIDDER WILL BE REQUIRED TO FILL IN AND SIGN A WRITTEN CONTRACT FORM (SBD7).					

BID RESPONSE DOCUMENTS MAY BE DEPOSITED IN THE BID BOX SITUATED AT (STREET ADDRESS)

DEPARTMENT OF TRANSPORT OFFICES
NO 92 CATHCARTH ROAD,SANLAM BUILDING
QUEENSTOWN
5320

SUPPLIER INFORMATION					
NAME OF BIDDER					
POSTAL ADDRESS					
STREET ADDRESS					
TELEPHONE NUMBER	CODE		NUMBER		
CELLPHONE NUMBER					
FACSIMILE NUMBER	CODE		NUMBER		
E-MAIL ADDRESS					
VAT REGISTRATION NUMBER					
	TCS PIN:		OR	CSD No:	
B-BBEE STATUS LEVEL VERIFICATION CERTIFICATE [TICK APPLICABLE BOX]	<input type="checkbox"/> Yes		B-BBEE STATUS LEVEL SWORN AFFIDAVIT	<input type="checkbox"/> Yes	

DESCRIPTION: SUPPLY AND DELIVERY OF PARK HOMES AT WHITTLESEA CAMP IN ENOCH MGIJIMA LOCAL MUNICIPAL ARE FOR THE CHRIS HAN DISTRICT AT THE DEPARTMENT OF TRANSPORT

	<input type="checkbox"/> No		<input type="checkbox"/> No
IF YES, WHO WAS THE CERTIFICATE ISSUED BY?			
AN ACCOUNTING OFFICER AS CONTEMPLATED IN THE CLOSE CORPORATION ACT (CCA) AND NAME THE APPLICABLE IN THE TICK BOX	<input type="checkbox"/>	AN ACCOUNTING OFFICER AS CONTEMPLATED IN THE CLOSE CORPORATION ACT (CCA)	
	<input type="checkbox"/>	A VERIFICATION AGENCY ACCREDITED BY THE SOUTH AFRICAN ACCREDITATION SYSTEM (SANAS)	
	<input type="checkbox"/>	A REGISTERED AUDITOR NAME:	
<i>[A B-BBEE STATUS LEVEL VERIFICATION CERTIFICATE/SWORN AFFIDAVIT(FOR EMEs& QSEs) MUST BE SUBMITTED IN ORDER TO QUALIFY FOR PREFERENCE POINTS FOR B-BBEE]</i>			
ARE YOU THE ACCREDITED REPRESENTATIVE IN SOUTH AFRICA FOR THE GOODS /SERVICES /WORKS OFFERED?	<input type="checkbox"/> Yes <input type="checkbox"/> No [IF YES ENCLOSE PROOF]	ARE YOU A FOREIGN BASED SUPPLIER FOR THE GOODS /SERVICES /WORKS OFFERED?	<input type="checkbox"/> Yes <input type="checkbox"/> No [IF YES ANSWER PART B:3 BELOW]
SIGNATURE OF BIDDER	DATE	
CAPACITY UNDER WHICH THIS BID IS SIGNED (Attach proof of authority to sign this bid; e.g. resolution of directors, etc.)			
TOTAL NUMBER OF ITEMS OFFERED		TOTAL BID PRICE (ALL INCLUSIVE)	
BIDDING PROCEDURE ENQUIRIES MAY BE DIRECTED TO:		TECHNICAL INFORMATION MAY BE DIRECTED TO:	
DEPARTMENT/ PUBLIC ENTITY	TRANSPORT	CONTACT PERSON	SOLOMZI LUNIKA
CONTACT PERSON		TELEPHONE NUMBER	071 490 8558
TELEPHONE NUMBER		FACSIMILE NUMBER	
FACSIMILE NUMBER		E-MAIL ADDRESS	Solomzi.lunika@ectransport.gov.za

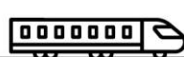

PART B
TERMS AND CONDITIONS FOR BIDDING

1. BID SUBMISSION:

- 1.1. BIDS MUST BE DELIVERED BY THE STIPULATED TIME TO THE CORRECT ADDRESS. LATE BIDS WILL NOT BE ACCEPTED FOR CONSIDERATION.
- 1.2. ALL BIDS MUST BE SUBMITTED ON THE OFFICIAL FORMS PROVIDED—(NOT TO BE RE-TYPED) OR ONLINE
- 1.3. BIDDERS MUST REGISTER ON THE CENTRAL SUPPLIER DATABASE (CSD) TO UPLOAD MANDATORY INFORMATION NAMELY: (BUSINESS REGISTRATION/ DIRECTORSHIP/ MEMBERSHIP/IDENTITY NUMBERS; TAX COMPLIANCE STATUS; AND BANKING INFORMATION FOR VERIFICATION PURPOSES). B-BBEE CERTIFICATE OR SWORN AFFIDAVIT FOR B-BBEE MUST BE SUBMITTED TO BIDDING INSTITUTION.
- 1.4. WHERE A BIDDER IS NOT REGISTERED ON THE CSD, MANDATORY INFORMATION NAMELY: (BUSINESS REGISTRATION/ DIRECTORSHIP/ MEMBERSHIP/IDENTITY NUMBERS; TAX COMPLIANCE STATUS MAY NOT BE SUBMITTED WITH THE BID DOCUMENTATION. B-BBEE CERTIFICATE OR SWORN AFFIDAVIT FOR B-BBEE MUST BE SUBMITTED TO BIDDING INSTITUTION.
- 1.5. THIS BID IS SUBJECT TO THE PREFERENTIAL PROCUREMENT POLICY FRAMEWORK ACT 2000 AND THE PREFERENTIAL PROCUREMENT REGULATIONS, 2017, THE GENERAL CONDITIONS OF CONTRACT (GCC) AND, IF APPLICABLE, ANY OTHER LEGISLATION OR SPECIAL CONDITIONS OF CONTRACT.
- 1.6. UPON THE DELIVERY ALL PARKHOME'S TO HAVE ALL THE NECESSARY MATERIAL TO CONNECT TO MUNICIPAL POWER, WATER AND SEWER CONNECTIONS.
- 1.7. THERE WILL BE A COMPULSORY BRIEFING HELD ON SITE ON THIS DATE **02/09/2024**

2. TAX COMPLIANCE REQUIREMENTS

- 2.1 BIDDERS MUST ENSURE COMPLIANCE WITH THEIR TAX OBLIGATIONS.
- 2.2 BIDDERS ARE REQUIRED TO SUBMIT THEIR UNIQUE PERSONAL IDENTIFICATION NUMBER (PIN) ISSUED BY SARS TO ENABLE THE ORGAN OF STATE TO VIEW THE TAXPAYER'S PROFILE AND TAX STATUS.
- 2.3 APPLICATION FOR TAX COMPLIANCE STATUS (TCS) OR PIN MAY ALSO BE MADE VIA E-FILING. IN ORDER TO USE THIS PROVISION, TAXPAYERS WILL NEED TO REGISTER WITH SARS AS E-FILERS THROUGH THE WEBSITE WWW.SARS.GOV.ZA.
- 2.4 BIDDERS MAY ALSO SUBMIT A PRINTED TCS TOGETHER WITH THE BID.
- 2.5 IN BIDS WHERE CONSORTIA / JOINT VENTURES / SUB-CONTRACTORS ARE INVOLVED, EACH PARTY MUST SUBMIT A SEPARATE PROOF OF TCS / PIN / CS
- 2.6 D NUMBER.
- 2.7 WHERE NO TCS IS AVAILABLE BUT THE BIDDER IS REGISTERED ON THE CENTRAL SUPPLIER

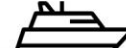
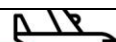

DATABASE (CSD), A CSD NUMBER MUST BE PROVIDED.

3. QUESTIONNAIRE TO BIDDING FOREIGN SUPPLIERS

- 3.1. IS THE BIDDER A RESIDENT OF THE REPUBLIC OF SOUTH AFRICA (RSA)? YES NO
- 3.2. DOES THE BIDDER HAVE A BRANCH IN THE RSA? YES NO
- 3.3. DOES THE BIDDER HAVE A PERMANENT ESTABLISHMENT IN THE RSA? YES NO
- 3.4. DOES THE BIDDER HAVE ANY SOURCE OF INCOME IN THE RSA? YES NO

IF THE ANSWER IS “NO” TO ALL OF THE ABOVE, THEN, IT IS NOT A REQUIREMENT TO OBTAIN A TAX COMPLIANCE STATUS / TAX COMPLIANCE SYSTEM PIN CODE FROM THE SOUTH AFRICAN REVENUE SERVICE (SARS) AND IF NOT REGISTER AS PER 2.3 ABOVE.

NB: FAILURE TO PROVIDE ANY OF THE ABOVE PARTICULARS MAY RENDER THE BID INVALID.

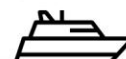
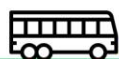

SUPPLY AND DELIVERY OF PARK HOMES AT WHITTLESEA CAMP IN THE ENOCH MGIJIMA LOCAL MUNICIPALITY AREA FOR THE CHRIS HANI DISTRICT AT THE DEPARTMENT OF TRANSPORT

ITEM NO	DESCRIPTION	UNIT OF MEASURE	QUANTITY	UNIT PRICE	TOTAL COST
01	Kitchen sink, cup boards, mixer include delivery to (Whittlesea)	4.2m x 2.4m	1		
02	Ablution and Change rooms 2 toilets 2 basins and 2 Showers include delivery to (Whittlesea)	6.0m x 3.0m	2		
03	Insulated Park Home (Rooms) 4 room, 4 ext. door light and window, double plug include delivery to (Whittlesea)	12m x 3m	2		
04	Material for services		-		
SUB TOTAL					
Vat 15% [only if eligible and registered]					
TOTAL AMOUNT OF QUOTATION					

NB

After service has been rendered the invoices must be submitted to the following email address: invoices@ectransport.gov.za

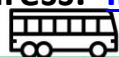

BID PRICING FORM

For ease of reference, Bidders shall enter their Bid Price, copied from the Pricing Schedule, in the space provided below. Should there be any discrepancy, then the sum calculated from the Pricing Schedule, subject to any arithmetic correction, shall hold precedence.

Total Price (amount in words):

.....

.....

....., inclusive of VAT

Total Price (amount in figures)

R, inclusive of VAT

NAME OF BIDDER:

.....

SIGNED ON BEHALF OF THE BIDDER:

.....

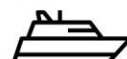
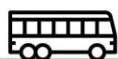

**PRICING SCHEDULE – FIRM PRICES
(PURCHASES)**

NOTE: ONLY FIRM PRICES WILL BE ACCEPTED. NON-FIRM PRICES (INCLUDING PRICES SUBJECT TO RATES OF EXCHANGE VARIATIONS) WILL NOT BE CONSIDERED

IN CASES WHERE DIFFERENT DELIVERY POINTS INFLUENCE THE PRICING, A SEPARATE PRICING SCHEDULE MUST BE SUBMITTED FOR EACH DELIVERY POINT

Name of bidder.....	Quote number : DOT-CHR-24/25-0031
Closing Time : 11H00	Closing date : 06-09-2023

OFFER TO BE VALID FOR 30 DAYS FROM THE CLOSING DATE OF QUOTE. _____

ITEM NO.	QUANTITY	DESCRIPTION	BID PRICE IN RSA CURRENCY ** (ALL APPLICABLE TAXES INCLUDED)
----------	----------	-------------	---

- Required by: DEPARTMENT OF TRANSPORT
- At: QUEENSTOWN
- Brand and model: N/A
- Country of origin:
- Does the offer comply with the specification(s)? *YES/NO
- If not to specification, indicate deviation(s)
- Period required for delivery
*Delivery: Firm/not firm
- Delivery basis:

Note: All delivery costs must be included in the bid price, for delivery at the prescribed destination.

** "all applicable taxes" includes value- added tax, pay as you earn, income tax, unemployment insurance fund contributions and skills development levies.

*Delete if not applicable



ECBD 4: BIDDER'S DISCLOSURE

1. PURPOSE OF THE FORM

Any person (natural or juristic) may make an offer or offers in terms of this invitation to bid. In line with the principles of transparency, accountability, impartiality, and ethics as enshrined in the Constitution of the Republic of South Africa and further expressed in various pieces of legislation, it is required for the bidder to make this declaration in respect of the details required hereunder.

Where a person/s are listed in the Register for Tender Defaulters and / or the List of Restricted Suppliers, that person will automatically be disqualified from the bid process.

2. BIDDER'S DECLARATION

2.1 Is the bidder, or any of its directors / trustees / shareholders / members / partners or any person having a controlling interest¹ in the enterprise, employed by the state?

YES/NO

2.1.1 If so, furnish particulars of the names, individual identity numbers, and, if applicable, state employee numbers of sole proprietor/ directors / trustees / shareholders / members/ partners or any person having a controlling interest in the enterprise, in table below.

Full Name	Identity Number	Name of State institution

1. the power, by one person or a group of persons holding the majority of the equity of an enterprise, alternatively, the person/s having the deciding vote or power to influence or to direct the course and decisions of the enterprise.

2. Joint venture or Consortium means an association of persons for the purpose of combining their expertise, property, capital, efforts, skill and knowledge in an activity for the execution of a contract.

--	--	--

2.2 Do you, or any person connected with the bidder, have a relationship with any person who is employed by the procuring institution? **YES/NO**

2.2.1 If so, furnish particulars:

.....

.....

2.3 Does the bidder or any of its directors / trustees / shareholders / members / partners or any person having a controlling interest in the enterprise have any interest in any other related enterprise whether or not they are bidding for this contract? **YES/NO**

2.3.1 If so, furnish particulars:

.....

.....

3 DECLARATION

I, the undersigned, (name)..... in submitting the accompanying bid, do hereby make the following statements that I certify to be true and complete in every respect:

- 3.1 I have read and I understand the contents of this disclosure;
- 3.2 I understand that the accompanying bid will be disqualified if this disclosure is found not to be true and complete in every respect;
- 3.3 The bidder has arrived at the accompanying bid independently from, and without consultation, communication, agreement or arrangement with any competitor. However, communication between partners in a joint venture or consortium² will not be construed as collusive bidding.
- 3.4 In addition, there have been no consultations, communications, agreements or arrangements with any competitor regarding the quality, quantity, specifications, prices, including methods, factors or formulas used to calculate prices, market allocation, the intention or decision to submit or not to submit the bid, bidding with the intention not to win the bid and conditions or delivery particulars of the products or services to which this bid invitation relates.
- 3.4 The terms of the accompanying bid have not been, and will not be, disclosed by the bidder, directly or indirectly, to any competitor, prior to the date and time of the official bid opening or of the awarding of the contract.
- 3.5 There have been no consultations, communications, agreements or arrangements made by the bidder with any official of the procuring institution in relation to this procurement process prior to and during the bidding process except to provide clarification on the bid submitted where so required by the institution; and the bidder was not involved in the drafting of the specifications or terms of reference for this bid.

DESCRIPTION: SUPPLY AND DELIVERY OF PARK HOMES AT WHITTLESEA CAMP IN ENOCH MGIJIMA LOCAL MUNICIPAL ARE FOR THE CHRIS HAN DISTRICT AT THE DEPARTMENT OF TRANSPORT

3.6 I am aware that, in addition and without prejudice to any other remedy provided to combat any restrictive practices related to bids and contracts, bids that are suspicious will be reported to the Competition Commission for investigation and possible imposition of administrative penalties in terms of section 59 of the Competition Act No 89 of 1998 and or may be reported to the National Prosecuting Authority (NPA) for criminal investigation and or may be restricted from conducting business with the public sector for a period not exceeding ten (10) years in terms of the Prevention and Combating of Corrupt Activities Act No 12 of 2004 or any other applicable legislation.

I CERTIFY THAT THE INFORMATION FURNISHED IN PARAGRAPHS 1, 2 and 3 ABOVE IS CORRECT.

I ACCEPT THAT THE STATE MAY REJECT THE BID OR ACT AGAINST ME IN TERMS OF PARAGRAPH 6 OF PFMA SCM INSTRUCTION 03 OF 2021/22 ON PREVENTING AND COMBATING ABUSE IN THE SUPPLY CHAIN MANAGEMENT SYSTEM SHOULD THIS DECLARATION PROVE TO BE FALSE.

.....
Signature	Date
.....
Position	Name of bidder



DECLARATION OF EMPLOYEES OF THE STATE OR OTHER STATE INSTITUTIONS

This form must be included additional to the ECBD.4

1. In terms of section 30 of the Public Service Act;

No employee shall perform or engage himself or herself to perform remunerative work outside his or her employment in the relevant department, except with the written permission of the executive authority of the department.

2.

Are any of the shareholders/ directors of your company employed by the State?	Yes/No
---	--------

3. "State" means –

- (a) Any national or provincial department, national or provincial public entity or constitutional institution within the meaning of the Public Finance Management Act, 1999 (Act No. 1 of 1999);
- (b) Any municipality or municipal entity;
- (c) Any provincial legislature;
- (d) national Assembly or the national Council of provinces; or
- (e) Parliament.
- (f) Any Parastatal (A company or agency owned or controlled wholly or partly by the government).

4. Should you indicate "yes" above, please provide the following details:

No	NAME & SURNAME OF DIRECTOR	STATE INSTITUTION WHERE EMPLOYED	ID NUMBER	EMPLOYEE/ PERSAL NUMBER
1				
2				
3				
4				
5				

5. **Please note: The "state" is clearly defined in paragraph 3 above. In the event that "no" is selected and subsequently any false declaration are detected, the non-disclosure of such "state employment" will be deemed as "fraud". Therefore the state may reject the bid and in addition may proceed with further action should this declaration prove to be false.**

6. DECLARATION

I, (NAME & SURNAME).....ID NUMBER..... CERTIFY THAT THE INFORMATION FURNISHED IN PARAGRAPHS 2 AND 4 ABOVE IS CORRECT.

..... Signature
 Date
 Position Name of bidder

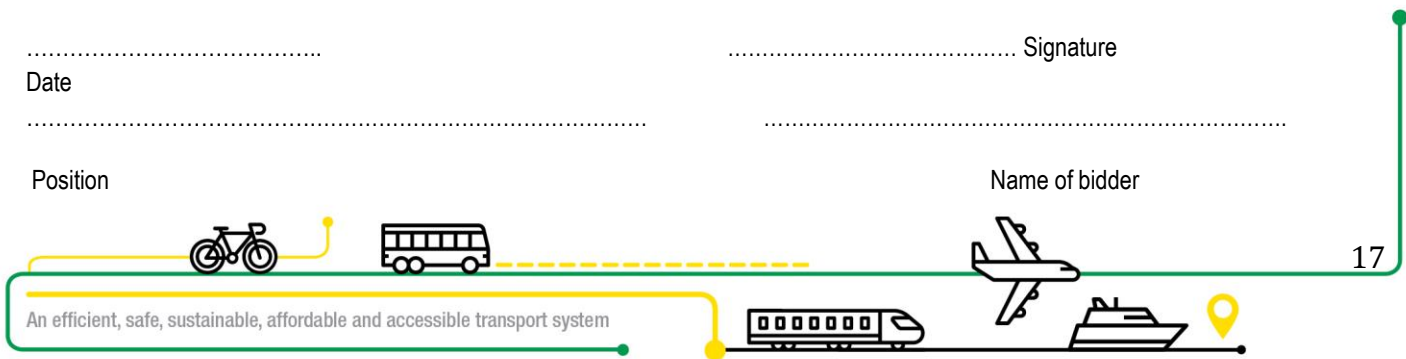

PREFERENCE POINTS CLAIM FORM IN TERMS OF THE PREFERENTIAL PROCUREMENT REGULATIONS 2022

This preference form must form part of all tenders invited. It contains general information and serves as a claim form for preference points for specific goals.

NB: BEFORE COMPLETING THIS FORM, TENDERERS MUST STUDY THE GENERAL CONDITIONS, DEFINITIONS AND DIRECTIVES APPLICABLE IN RESPECT OF THE TENDER AND PREFERENTIAL PROCUREMENT REGULATIONS, 2022

1. GENERAL CONDITIONS

1.1 The following preference point systems are applicable to invitations to tender:

- the 80/20 system for requirements with a Rand value of up to R50 000 000 (all applicable taxes included); and
- the 90/10 system for requirements with a Rand value above R50 000 000 (all applicable taxes included).

1.2 **To be completed by the organ of state**

(delete whichever is not applicable for this tender).

- a) The applicable preference point system for this tender is the **80/20** preference point system.
- b) Either the **90/10 or 80/20 preference point system** will be applicable in this tender. The lowest/highest acceptable tender will be used to determine the accurate system once tenders are received.

1.3 Points for this tender (even in the case of a tender for income-generating contracts) shall be awarded for:

- (a) Price; and
- (b) Specific Goals.

1.4 **To be completed by the organ of state:**

The maximum points for this tender are allocated as follows:

	POINTS
PRICE	80
SPECIFIC GOALS	20
Total points for Price and SPECIFIC GOALS	100

1.5 Failure on the part of a tenderer to submit proof or documentation required in terms of this tender to claim points for specific goals with the tender, will be interpreted to mean that preference points for specific goals are not claimed.



DESCRIPTION: SUPPLY AND DELIVERY OF PARK HOMES AT WHITTLESEA CAMP IN ENOCH MGIJIMA LOCAL MUNICIPAL ARE FOR THE CHRIS HAN DISTRICT AT THE DEPARTMENT OF TRANSPORT

1.6 The organ of state reserves the right to require of a tenderer, either before a tender is adjudicated or at any time subsequently, to substantiate any claim in regard to preferences, in any manner required by the organ of state.

2. DEFINITIONS

- (a) **“tender”** means a written offer in the form determined by an organ of state in response to an invitation to provide goods or services through price quotations, competitive tendering process or any other method envisaged in legislation;
- (b) **“price”** means an amount of money tendered for goods or services, and includes all applicable taxes less all unconditional discounts;
- (c) **“rand value”** means the total estimated value of a contract in Rand, calculated at the time of bid invitation, and includes all applicable taxes;
- (d) **“tender for income-generating contracts”** means a written offer in the form determined by an organ of state in response to an invitation for the origination of income-generating contracts through any method envisaged in legislation that will result in a legal agreement between the organ of state and a third party that produces revenue for the organ of state, and includes, but is not limited to, leasing and disposal of assets and concession contracts, excluding direct sales and disposal of assets through public auctions; and
- (e) **“the Act”** means the Preferential Procurement Policy Framework Act, 2000 (Act No. 5 of 2000).

3. FORMULAE FOR PROCUREMENT OF GOODS AND SERVICES

3.1. POINTS AWARDED FOR PRICE

3.1.1 THE 80/20 OR 90/10 PREFERENCE POINT SYSTEMS

A maximum of 80 or 90 points is allocated for price on the following basis:

$$Ps = 80 \left(1 - \frac{Pt - P_{min}}{P_{min}} \right) \text{ or } Ps = 90 \left(1 - \frac{Pt - P_{min}}{P_{min}} \right)$$

Where

- Ps = Points scored for price of tender under consideration
- Pt = Price of tender under consideration
- Pmin = Price of lowest acceptable tender

3.2. FORMULAE FOR DISPOSAL OR LEASING OF STATE ASSETS AND INCOME GENERATING PROCUREMENT

3.2.1. POINTS AWARDED FOR PRICE

A maximum of 80 or 90 points is allocated for price on the following basis:

80/20 or 90/10



$$Ps = 80 \left(1 + \frac{Pt - Pmax}{Pmax} \right) \text{ or } Ps = 90 \left(1 + \frac{Pt - Pmax}{Pmax} \right)$$

Where

- Ps = Points scored for price of tender under consideration
- Pt = Price of tender under consideration
- Pmax = Price of highest acceptable tender

4. POINTS AWARDED FOR SPECIFIC GOALS

- 4.1. In terms of Regulation 4(2); 5(2); 6(2) and 7(2) of the Preferential Procurement Regulations, preference points must be awarded for specific goals stated in the tender. For the purposes of this tender the tenderer will be allocated points based on the goals stated in table 1 below as may be supported by proof/ documentation stated in the conditions of this tender:
- 4.2. In cases where organs of state intend to use Regulation 3(2) of the Regulations, which states that, if it is unclear whether the 80/20 or 90/10 preference point system applies, an organ of state must, in the tender documents, stipulate in the case of—
 - (a) an invitation for tender for income-generating contracts, that either the 80/20 or 90/10 preference point system will apply and that the highest acceptable tender will be used to determine the applicable preference point system; or
 - (b) any other invitation for tender, that either the 80/20 or 90/10 preference point system will apply and that the lowest acceptable tender will be used to determine the applicable preference point system,
 then the organ of state must indicate the points allocated for specific goals for both the 90/10 and 80/20 preference point system.

FORMULAE FOR CALCULATION POINTS

To Score points for Equity Ownership / Disability/ Locality the following formula will be used to calculate the points out of 5 points Max.

$$SGP = \frac{\%OE (CIPC / from BBBEE)}{100} \times MEO(Max = 4)$$

$$(e.g) \text{ Women Equity Ownership} = \frac{89}{100} \times 4 = 3,56$$

Where

- SGP= Specific goals points
- OE = Ownership Equity
- MOE= Maximum points for Equity Ownership

Table 1: Specific goals for the tender and points claimed are indicated per the table below.

(Note to organs of state: Where either the 90/10 or 80/20 preference point system is applicable, corresponding points must also be indicated as such.

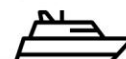
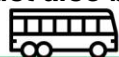

Note to tenderers: The tenderer must indicate how they claim points for each preference point system.)

PREFERENTIAL SPECIFIC GOALS POINTS TABLE		
The specific goals allocated points in terms of this tender	Number of points allocated (80/20 system) (To be completed by the organ of state)	Number of points claimed (80/20 system) (To be completed by the tenderer)
Historically Disadvantaged Individuals		
black ownership	4	
black women ownership	4	
black youth ownership	4	
disabled people ownership	4	
Locality:-		
(a) Within the Chris Hani District Municipality	4	
(b) Outside the Chris Hani District Municipality	2	

DECLARATION WITH REGARD TO COMPANY/FIRM

4.3. Name of company/firm.....

4.4. Company registration number:

4.5. TYPE OF COMPANY/ FIRM

- Partnership/Joint Venture / Consortium
- One-person business/sole propriety
- Close corporation
- Public Company
- Personal Liability Company
- (Pty) Limited
- Non-Profit Company
- State Owned Company

[TICK APPLICABLE BOX]

4.6. I, the undersigned, who is duly authorised to do so on behalf of the company/firm, certify that the points claimed, based on the specific goals as advised in the tender, qualifies the company/ firm for the preference(s) shown and I acknowledge that:

- i) The information furnished is true and correct;
- ii) The preference points claimed are in accordance with the General Conditions as indicated in paragraph 1 of this form;
- iii) In the event of a contract being awarded as a result of points claimed as shown in paragraphs 1.4 and 4.2, the contractor may be required to furnish documentary proof to the satisfaction

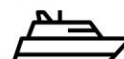
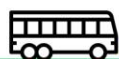

DESCRIPTION: SUPPLY AND DELIVERY OF PARK HOMES AT WHITTLESEA CAMP IN ENOCH MGIJIMA LOCAL MUNICIPAL ARE FOR THE CHRIS HAN DISTRICT AT THE DEPARTMENT OF TRANSPORT

of the organ of state that the claims are correct;

iv) If the specific goals have been claimed or obtained on a fraudulent basis or any of the conditions of contract have not been fulfilled, the organ of state may, in addition to any other remedy it may have –

- (a) disqualify the person from the tendering process;
- (b) recover costs, losses or damages it has incurred or suffered as a result of that person's conduct;
- (c) cancel the contract and claim any damages which it has suffered as a result of having to make less favourable arrangements due to such cancellation;
- (d) recommend that the tenderer or contractor, its shareholders and directors, or only the shareholders and directors who acted on a fraudulent basis, be restricted from obtaining business from any organ of state for a period not exceeding 10 years, after the *audi alteram partem* (hear the other side) rule has been applied; and
- (e) forward the matter for criminal prosecution, if deemed necessary.

.....

SIGNATURE(S) OF TENDERER(S)

SURNAME AND NAME:

DATE:

ADDRESS:

.....

.....

GENERAL CONDITIONS OF CONTRACT

- The latest General Conditions of Contract [GCC] and Contract Law shall be applicable to this Quotation and obtainable by visiting the National Treasury website at www.treasury.gov.za
- Bidders must familiarize themselves with these GCCs

